

THE INFORMATION CONTAINED IN THIS DRAWING IS THE SOLE PROPERTY OF VTE INCORPORATED. ANY REPRODUCTION IN PART OR WHOLE WITHOUT THE WRITTEN PERMISSION OF VTE INCORPORATED IS PROHIBITED. VTE MAKES NO WARRANTY, EXPRESSED OR IMPLIED, AS TO THE SUITABILITY OF A PRODUCT FOR ANY INTENDED USE. THE CUSTOMER SHALL BEAR THE SOLE RESPONSIBILITY OF DETERMINING THE SUITABILITY OF ANY VTE PRODUCT FOR ITS END USE.

LTR.	REVISIONS	DATE	INT.
	PRELIMINARY DRAWING FOR APPROVAL	11-12-20	EJE

USE GREENLEE PUNCH
ASSEMBLY #60098
FOR PANEL CUTOUT

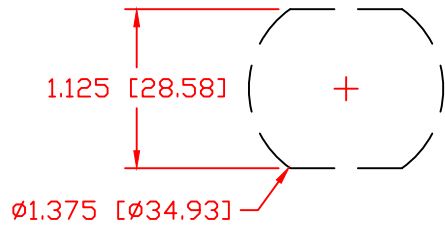

ASSEMBLY
CCFB378N05W
CONSIST OF :

- 1-CCFB378N05
POWER BUSHING
- 1-3960-002
SEALING GASKET
- 1-232N3V05
INSULATOR BOOT

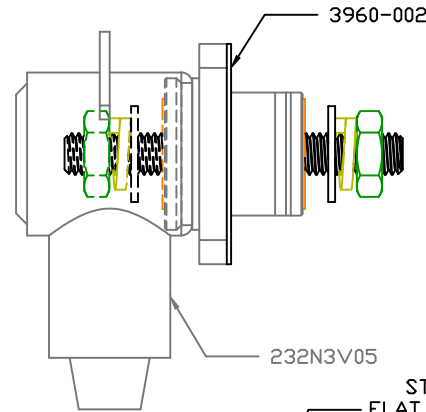

P/N 3960-002
.062 THICK CF 4480 81 DUROMETER
FIBERGLASS REINFORCED SILICONE
PRESS PAD SEALING GASKET

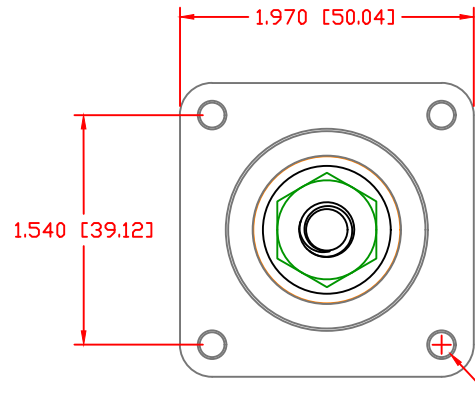
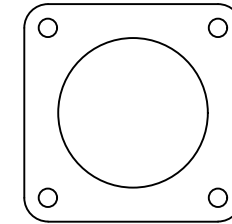

3844-012 3/8"-16
STAINLESS STEEL
JAM NUT (2) REQ'D

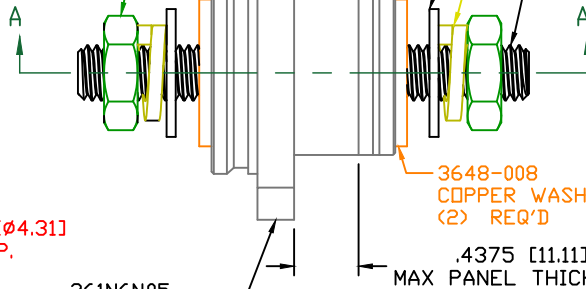

361N6N05
GLASS FILLED
NYLON BUSHING

3646-000
STAINLESS STEEL
FLAT WASHER (2) REQ'D

3638-000 LOCK WASHER
STAINLESS STEEL (2) REQ'D

3742-007
NICKEL PLATED
MOUNTING STUD

3648-008
COPPER WASHER
(2) REQ'D

.4375 [11.11]
MAX PANEL
THICKNESS

3863-002
COPPER CORE

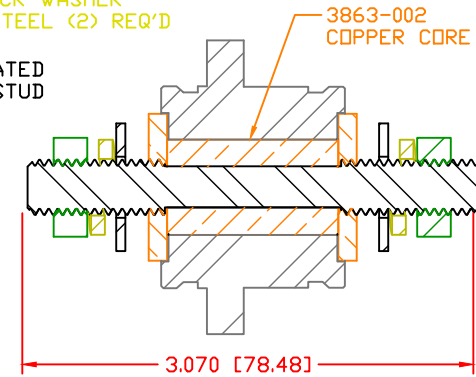

SECTION A-A

SCALE FACTOR : NONE
ALL DIMENSIONS GIVEN AS: in [mm]
TOLERANCES UNLESS OTHERWISE SPECIFIED :
MOLDED PARTS: ±.030" [±0.8mm]
HARDWARE ITEMS: ±.010" [±0.25mm]

MAXIMUM FASTENER TORQUES:
JAM NUTS: 212 IN-LBS [24.0 Nm]

CURRENT CARRYING CAPACITY:
DUTY CYCLE:
CURRENT CAPACITY:
TEMPORARY MAX (12 MINUTES)

80%
7.2 Kw (600 AMP @ 12VDC)
9.0 Kw (750 AMP @ 12VDC)

MATERIAL PART NO:
MATERIAL:
VENDOR PART NO:
SPECIFIC GRAVITY:
MELTING TEMP:
U.L. RATING:

7111210505
GLASS FILLED NYLON
HYLON N2015 HL NAT
1.23
515 F [268 C]
UL 94 HB

		VTE Incorporated 5437 Robinson Road, P.O. Box 790 Pellston, Michigan 49769 Telephone: 1-800-527-9256, 231-539-8000 FAX: 231-539-0914	
		REF:	DATE: 11-12-2020
TITLE: 3/8" WEATHERPROOF PANEL MOUNT POWER BUSHING, HIGH CAPACITY			
MATERIAL: GLASS FILLED NYLON		PART NO. CCFB378N05W	
COLOR: YELLOW	DRG CLASS: PRELIM		